



Set-Based Modeling in LocalSolver 6.0

www.localsolver.com

Who we are



Bouygues, one of the French largest corporation, €33 bn in revenues
<http://www.bouygues.com>

Innovation24

Operations Research subsidiary of Bouygues
20 years of practice and research
<http://www.innovation24.fr>

LocalSolver

Mathematical optimization solver
commercialized by Innovation 24
<http://www.localsolver.com>



LocalSolver

Hybrid math optimization solver

For combinatorial, numerical,
or mixed-variable optimization

Suited for large-scale
non-convex optimization

Quality solutions in seconds
without tuning

LocalSolver
=
LS + CP/SAT + LP/MIP + NLP

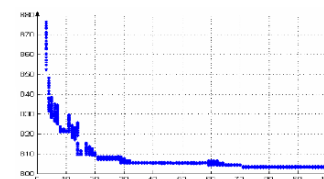
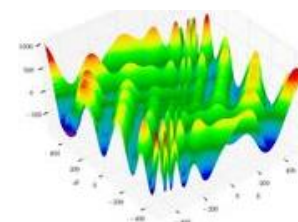

free trial with support – free for academics – renting licenses
from 590 €/month – perpetual licenses from 9,900 €

www.localsolver.com

Motivations

Modeling approaches for
the *Traveling Salesman Problem*



Mixed-Integer Programming

With an **exponential number** of constraints



$$\text{Minimise } \sum_{\substack{i,j \\ i \neq j}} c_{ij} x_{ij}$$

Conventional Formulation (C) (Dantzig, Fulkerson and Johnson (1954))

$$\sum_{\substack{j \\ j \neq i}} x_{ij} = 1 \quad \forall i \in N$$

$$\sum_{\substack{i \\ i \neq j}} x_{ij} = 1 \quad \forall j \in N$$

$$\sum_{\substack{i,j \in M \\ i \neq j}} x_{ij} \leq |M| - 1 \quad \forall M \subset N \text{ such that } \{1\} \notin M, |M| \geq 2$$

→ Iterative procedure to add subtour elimination constraints

Variant with $O(n^2)$ variables and constraints



SINGLE COMMODITY FLOW (F1) (Gavish and Graves (1978))

Both constraints are retained but we also introduce (continuous) variables:

y_{ij} = 'Flow' in an arc (i,j) $i \neq j$

and constraints:

$$y_{ij} \leq (n-1)x_{ij} \quad \forall i,j \in N, i \neq j$$

$$\sum_{\substack{j \\ j \neq 1}} y_{1j} = n-1$$

$$\sum_{\substack{i \\ i \neq j}} y_{ij} - \sum_{\substack{k \\ i \neq k}} y_{jk} = 1 \quad \forall j \in N - \{1\}$$



LocalSolver 5.0

A compact model based on positions

```
/* Declares the optimization model. */  
function model() {  
    // x[i][j] equal to 1 if city j is ith visited city in the tour  
    x[0..nbCities-1][0..nbCities-1] <- bool();  
  
    // one city per position i  
    for [i in 0..nbCities-1] constraint sum[j in 0..nbCities-1] (x[i][j]) == 1;  
    // one position per city j  
    for [j in 0..nbCities-1] constraint sum[i in 0..nbCities-1] (x[i][j]) == 1;  
  
    //city[i] is the city at position i in the tour  
    city[i in 0..nbCities-1] <- sum[j in 0..nbCities-1] (j*x[i][j]);  
  
    // Distance of the arc reaching the ith city  
    distance[0] <- distanceWeight[city[nbCities - 1]][city[0]];  
    distance[i in 1..nbCities - 1] <- distanceWeight[city[i - 1]][city[i]];  
  
    // Minimize the total distance  
    obj <- sum[i in 0..nbCities - 1] (distance[i]);  
  
    minimize obj;  
}
```

- A polynomial-size model (not an iterative procedure)
- No artificial variables and constraints
- But still based on binary decisions



Natural Modeling

As a permutation

The Traveling Salesman Problem (TSP)

TSP: Given a list of cities and their pairwise distances, find a shortest possible tour that visits each city exactly once.

Objective: find a permutation a_1, \dots, a_n of the cities that minimizes

$$d(a_1, a_2) + d(a_2, a_3) + \dots + d(a_{n-1}, a_n) + d(a_n, a_1)$$

where $d(i, j)$ is the distance between cities i and j



An optimal TSP tour through Germany's 15 largest cities



Reference modeling

Garey & Johnson

[ND22] TRAVELING SALESMAN

INSTANCE: Set C of m cities, distance $d(c_i, c_j) \in \mathbb{Z}^+$ for each pair of cities $c_i, c_j \in C$, positive integer B .

QUESTION: Is there a tour of C having length B or less, i.e., a permutation $\langle c_{\pi(1)}, c_{\pi(2)}, \dots, c_{\pi(m)} \rangle$ of C such that

$$\left(\sum_{i=1}^{m-1} d(c_{\pi(i)}, c_{\pi(i+1)}) \right) + d(c_{\pi(m)}, c_{\pi(1)}) \leq B \quad ?$$



Set-based modeling

Innovative modeling concepts
for routing & scheduling problems



List Variables

Structured decisional operator `list(n)`

- Order a **subset** of values in domain $\{0, \dots, n-1\}$
- Each value is **unique** in the list

Classical operators to interact with “list”

- **count**(u): number of values selected in the list
- **at**(u,i) or `u[i]`: value at index i in the list
- **indexOf**(u,v): index of value v in the list
- **contains**(u,v): equivalent to “`indexOf(u,v) != -1`”
- **disjoint**(u1, u2, ..., uk): true if u1, u2, ..., uk are pairwise disjoint
- **partition**(u1, u2, ..., uk): true if u1, u2, ..., uk induce a partition of $\{0, \dots, n-1\}$



Traveling salesman

```
function model() {  
  x <- list(N) ; // order n cities {0, ..., n-1} to visit  
  constraint count(x) == N; // exactly n cities to visit  
  minimize sum[i in 1..N-1]( Dist[ x[i-1] ][ x[i] ] )  
    + Dist[ x[N-1] ][ x[0] ] ; // minimize sum of traveled distances  
}
```

TSP: Given a list of cities and their pairwise distances, find a shortest possible tour that visits each city exactly once.

Objective: find a permutation a_1, \dots, a_n of the cities that minimizes

$$d(a_1, a_2) + d(a_2, a_3) + \dots + d(a_{n-1}, a_n) + d(a_n, a_1)$$

where $d(i, j)$ is the distance between cities i and j



An optimal TSP tour through Germany's 15 largest cities

Why not a single line model ?

constraint TSP (graph) ;



Real-world models do not fit in tight frameworks

$$\text{Time}[A, B, T] = \frac{2(\alpha_x^2 + \alpha_y^2)}{-2(\alpha_x \beta_x + \alpha_y \beta_y) + \sqrt{4(\alpha_x \beta_x + \alpha_y \beta_y)^2 - 4(\alpha_x^2 + \alpha_y^2)(\beta_x^2 + \beta_y^2 - V^2)}} + T$$

With $\alpha_x, \beta_x, \alpha_y, \beta_y$ function of A, B and T

constraint TSP (graph) ; ?

Kinetic TSP



Performance ?

TSP: real-life 200-client instance
LocalSolver 5.0 vs 5.5 (with operator *list*)

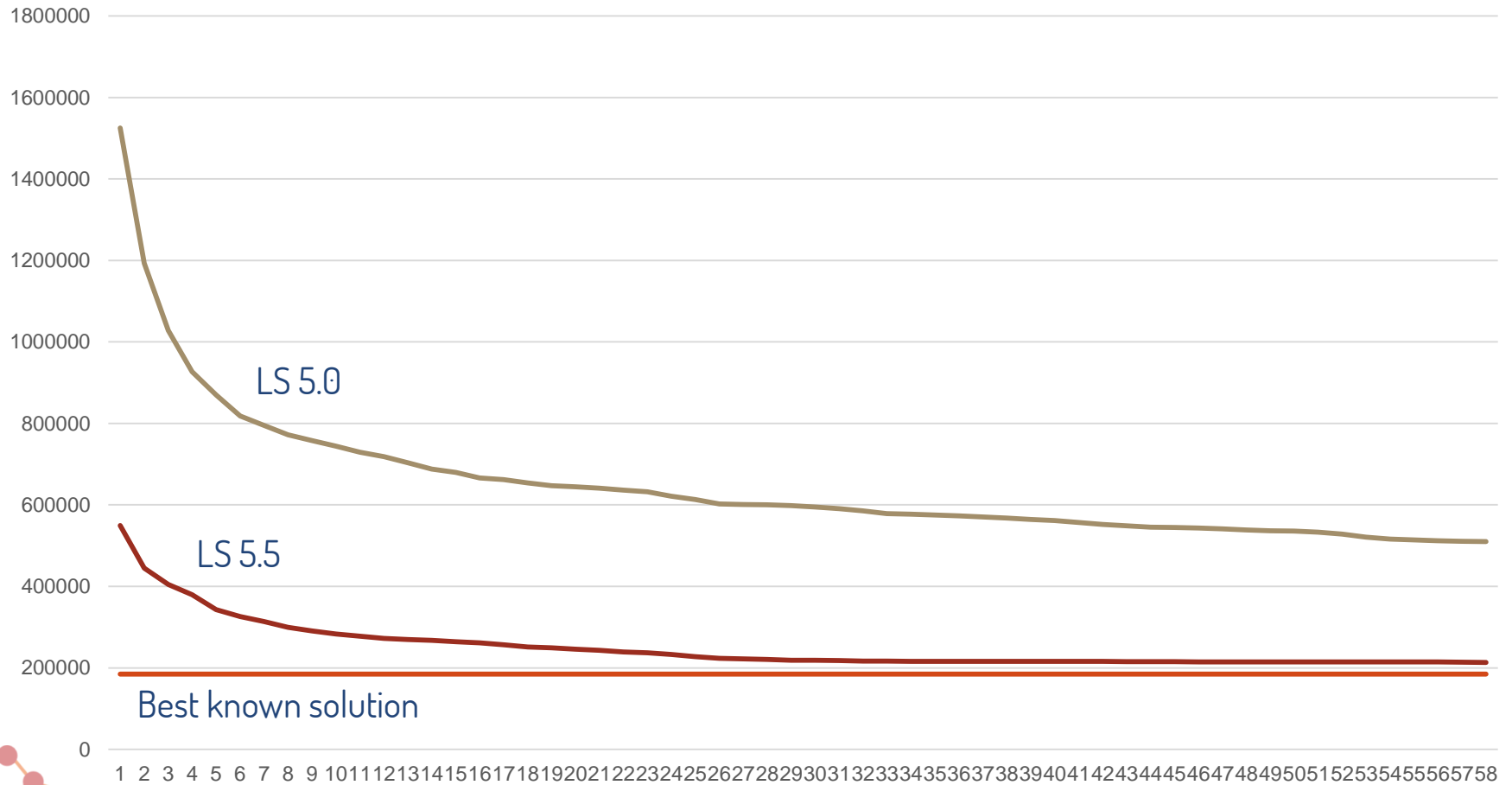

Vehicle routing

```
function model() {  
  x[1..K] <- list(N) ; // for each truck, order the clients to visit  
  constraint partition( x[1..K] ); // each client is visited once  
  distances[k in 1..K] <- sum[i in 1..N-1]( dist( x[k][i-1], x[k][i] )  
    + dist( x[k][N-1], x[k][0] ) ); // traveled distance for each truck  
  minimize sum[k in 1..K]( distances[k] ); // minimize total traveled distance  
}
```

	TSP	VRP
Normal	Count(x)=N	partition(x[1..K])
Prize-collecting	maximize sum(...)	disjoint(x[1..K])



CVRP benchmarks

CVRP – instances A

- 32 to 80 clients, 10 trucks max.
- 27 instances
- 5 minutes of running time
- LS binary: almost infeasible
- **LS list: 1 % avg. opt. gap**

CVRP – instances X100–500

- 100 to 500 clients, 138 trucks max.
- 67 instances
- 5 minutes of running time
- LS binary: almost infeasible
- **LS list: 9 % avg. opt. gap**



CVRPTW benchmarks

CVRPTW – instances Solomon R100

- 101 to 112 clients, 19 trucks max.
- 13 instances
- 5 minutes of running time
- LS binary: N/A
- **LS list: 3 % avg. opt. gap**

CVRPTW – instances Solomon R200

- 201 to 208 clients, 4 trucks max.
- 8 instances
- 5 minutes of running time
- LS binary: N/A
- **LS list: 8 % avg. opt. gap**



Beyond routing problems

Scheduling, planning, sequencing



Search docs

Installation & licensing

Quick start guide

Advanced features

LSP Reference Manual

Example tour

Toy

Knapsack

P-median

Branin function

Optimal bucket

Smallest circle

Max cut

Social golfer

Car sequencing

Steel mill slab design

K-means

Travelling salesman problem

Quadratic assignment problem

Flowshop

Vehicule routing problem

Python API Reference

C++ API Reference

Java API Reference

Docs » Example tour

Example tour



Toy ★



Knapsack ★

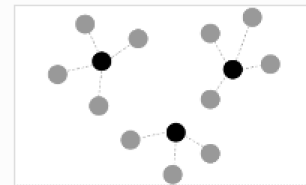

P-median ★

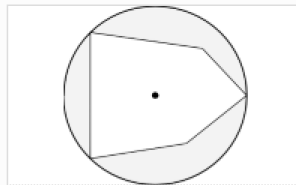

Smallest circle ★

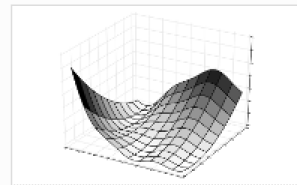

Branin function ★

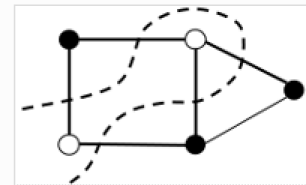

Max cut ★



Car sequencing ★★



Social golfer ★★

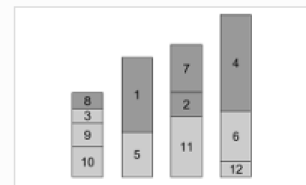

Steel mill slab design ★★

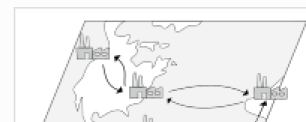
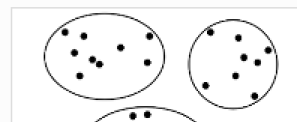
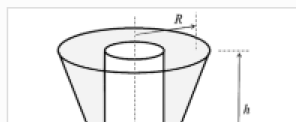

Flow-shop scheduling

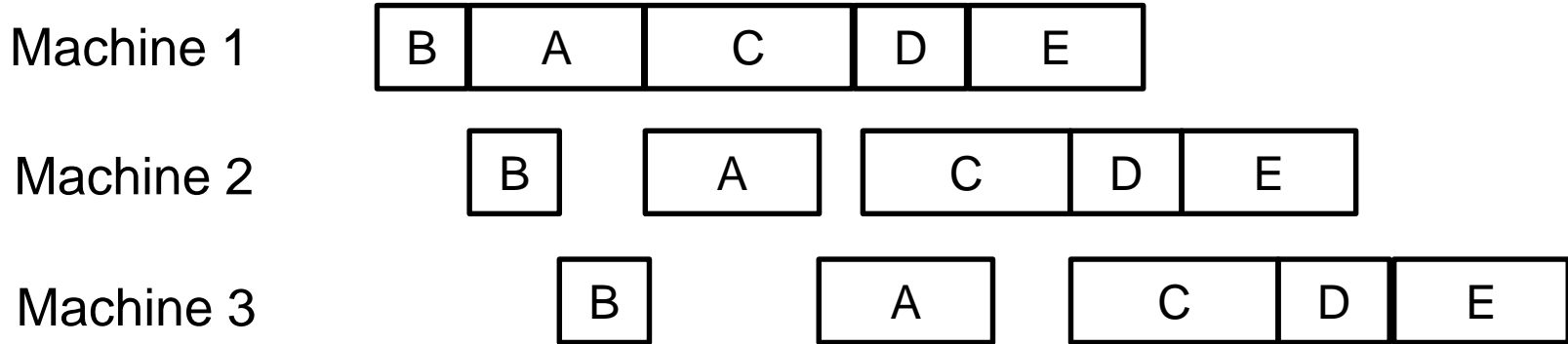

Since we are looking for a permutation of jobs the model is straightforward with a single list variable



Planning

Flights to plane assignments

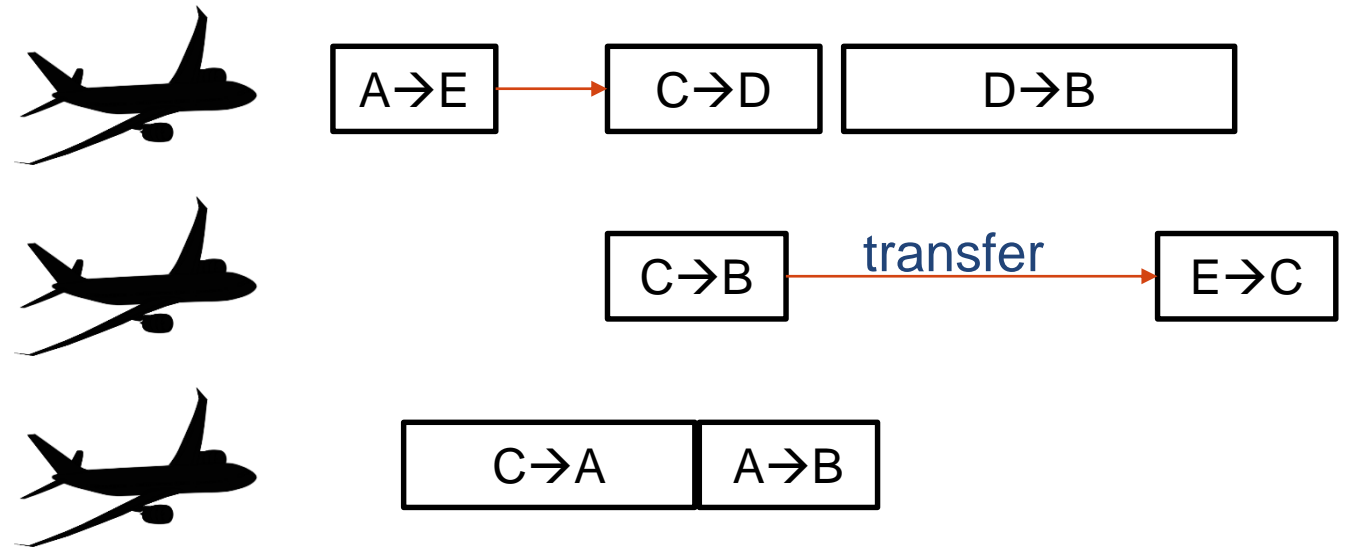

A solution is a partition of flights into K lists (one per plane)

The goal is to minimize the total transfer times



Conclusion

List Variables are a first step towards set-based modeling in LocalSolver

This higher level of modeling yields simple and compact models producing high quality solutions for

Routing



Scheduling

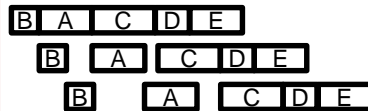

Planning



RCPSP



Any other sequencing problem